

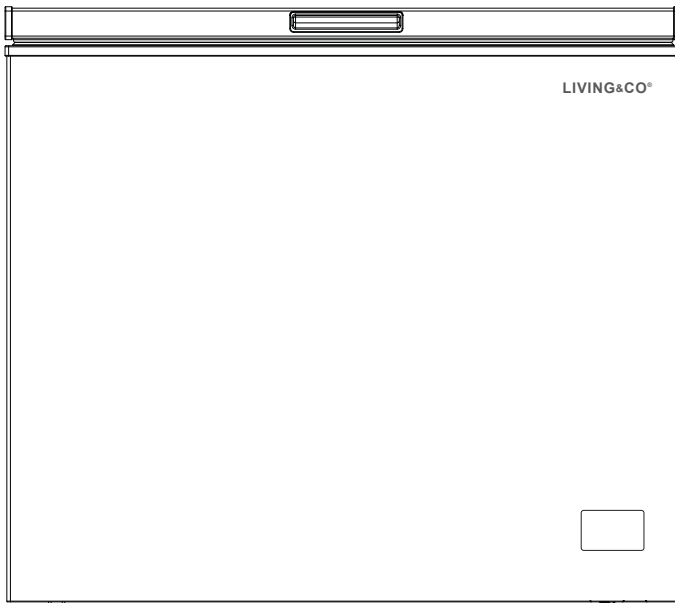

LIVING & CO[®]

Chest Freezer

Models HS-384CN & HS-185CN



User Manual

AFTER SALES SUPPORT



  0800 422 274







TABLE OF CONTENTS

| | |
|------------------------|-------|
| 1. Safety Instructions | P. 4 |
| 2. Product Overview | P. 8 |
| 3. Getting Started | P. 9 |
| 4. Use | P. 10 |
| 5. Troubleshooting | P. 13 |
| 6. Care and Cleaning | P. 15 |
| 7. Technical Data | P. 17 |
| 8. Notice | P. 17 |





1. Safety Instructions

IMPORTANT SAFETY INSTRUCTIONS READ CAREFULLY AND KEEP FOR FUTURE REFERENCE

Read this manual thoroughly before first use, even if you are familiar with this type of product. The safety precautions enclosed herein reduce the risk of fire, electric shock and injury when correctly adhered to. **Keep the manual in a safe place for future reference**, along with the completed warranty card, purchase receipt and carton. If applicable, pass these instructions on to the next owner of the appliance.



Pay particular attention to messages that follow this safety alert symbol or the words **DANGER**, **WARNING** or **CAUTION**. These words are used to alert you to a potential hazard that can seriously injure you and others. The instructions will tell you how to reduce the risk of injury and let you know what can happen if the instructions are not followed.



WARNING:
Risk of fire

This symbol alerts you to take care as the appliance contains flammable materials: Isobutane as refrigerant and cyclopentane as insulation blowing gas. Do not expose it to high heat, sparks and open flames.

The refrigerant isobutane (R600a) is contained within the refrigerant circuit of the appliance, a gas with a high level of environmental compatibility, which is nevertheless flammable. During transportation and installation of the appliance, ensure that none of the components of the refrigerant circuit become damaged.





WARNING: Do not damage the refrigerant circuit! Never use an appliance with a damaged refrigerant circuit! If the refrigerant circuit becomes damaged, avoid proximity to open fires and all types of heat and ignition sources. Thoroughly ventilate the room in which the appliance is located.

It is hazardous for anyone other than an authorized service person to service this appliance.

To reduce the risk of fire, electric shock or injury, always follow basic safety precautions and accident prevention measures when using this appliance, including the following:

1.1 Installation

- **Heavy:** This appliance is heavy, take care when moving it. To avoid back or other injury, consider a two person lift or mechanical aid when installing it. Failure to do so can result in back or other injury.
- **Damage:** When unpacking, check the appliance carefully for damage. If it is damaged, do not install the appliance. Contact our customer support centre for advice on examination or return of the damaged appliance.
- **Protect from moisture:** Install the appliance in an indoor area protected from wind, rain, water spray or drips.
- **Protect from heat:** Do not install it next to an oven, grill or other source of high heat, or where it will be exposed to direct sunlight for prolonged periods of time.
- **WARNING: Ventilation:** To ensure proper ventilation, keep any ventilation openings, in the appliance enclosure or in the built-in structure, clear of obstructions. Ensure adequate air circulation around the appliance to prevent overheating.
- **Level:** Install the appliance level in order to ensure proper operation.





1.2 Electrical Safety

- **Voltage:** Plug the appliance in a 220-240V, 50Hz, properly earthed power outlet, which must be in good working order. Make sure your outlet voltage and circuit frequency correspond to the voltage stated on the appliance rating label.
- **Power connection:** Do not use an adaptor; do not use an extension cord. Plug the power plug directly into a power point that cannot easily be turned off accidentally, and that is easily accessible so you can switch it off when required.
- **Power cord:** Do not kink or damage the power supply cord. Do not leave it exposed or dangling. Secure it behind the appliance so no one steps on or places anything on the power supply cord or against it. A squashed or damaged power plug may overheat and cause a fire.
- **Damaged cord:** Do not use a cord that shows cracks or abrasion damage along its length or at either end. Any damage to the cord may cause a short circuit, fire and/or electric shock. If the power cord is damaged, it must be replaced by the manufacturer or its service agent. Contact the customer sales support line for advice.
- **Disconnection:** Never unplug the unit by pulling the cord. Always grip the plug firmly and pull straight out from the power point.
- **Electrical work:** If the installation of this appliance requires any electrical work, make sure it is carried out by a qualified electrician.

1.3 Usage Conditions and Restrictions

- **Indoor domestic use only:** This appliance is intended for indoor domestic use only, which includes use in households, staff kitchen areas in shops, offices, in farm houses and in other working environments, use by clients in hotels, motels, bed and breakfast establishments, other residential type environments and in catering and similar non-retail applications. It is not suitable for industrial or commercial use.
- **Intended purpose:** Do not use this appliance for anything other than its intended purpose, and only use it as described in this manual. Do not attempt to alter or modify this appliance in any way.





- **Usage restrictions:** The appliance can be used by children aged from 8 years and above, and persons with reduced physical, sensory or mental capabilities, or lack of experience and knowledge, if they have been given supervision or instruction concerning use of the appliance in a safe way and understand the hazards involved.
- **Children:** Supervise children to ensure they do not play with the appliance. Never allow children to operate, play with or crawl inside the appliance.
Cleaning and user maintenance shall not be made by children unless they are aged from 8 years and above and supervised.
- **WARNING!** Do not use any **electrical appliances** (such as ice cream makers) inside refrigeration appliances, unless they are approved for this purpose by the manufacturer.

1.4 Cleaning and Maintenance

- **Disconnect:** Unplug the appliance before cleaning or servicing. Failure to do so can result in electric shock, injury or death. Do not connect or disconnect the plug when your hands are wet.
- **Flames:** Do not let open flames or ignition sources enter the appliance.
- **Flammable/explosive substances:** Never clean this appliance with flammable fluids. Do not store or use volatile, flammable or explosive propellants or liquids in or close to this or any other appliance. The fumes can create a fire hazard or explosion.
- **Solvents:** Do not use solvent-based cleaning agents or abrasives on the interior as these may damage or discolor the surfaces of the appliances.
- **WARNING!** Do not use **mechanical devices** or other means to accelerate the defrosting process. Never use a sharp or metal instrument to remove frost or clean the appliance. Use a plastic scraper, if necessary.





- **Service:** Do not attempt to repair, modify or replace any part of the appliance unless specifically recommended in this manual. Refer all other servicing to a qualified technician, or contact the after sales support line for advice on examination or repair of the appliance.

2. Product Overview

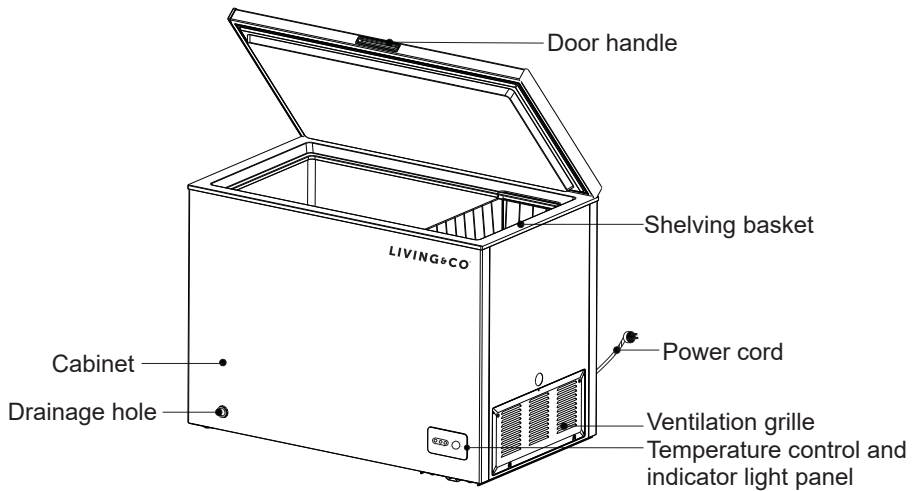
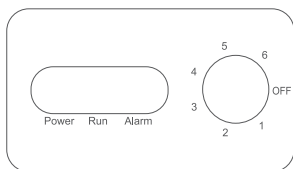

Image for reference only



2.1 Control Panel



Indicator lights Thermostat knob

“**Power**” indicator will illuminate when the unit has been connected to the mains supply.

“**Run**” indicator will illuminate when the compressor is in operation.

“**Alarm**” indicator will illuminate if the compressor has been operating, but the preset temperature cannot be achieved. Note, if starting from ambient, the light may illuminate for a period of 1 - 3 hours. Ensure cabinet is empty prior to achieving the required temperature.

“**OFF**” Turns the freezer off.

*The temperature of the freezer is adjusted through the thermostat knob. The numbers “1, 2, 3, 4, 5, 6” indicate the different levels (1 is approximately -10°C, 3 is approximately -17°C and 6 is approximately -24°C. Operating temperatures will vary depending on ambient temperature/ frequency of the door being opened.

NOTES:

- The first time you turn the unit on, set the temperature control to the highest position (6). Then, after 24 hours, adjust the temperature control to the setting that suits your needs, position 4 or 5 should be appropriate for normal use.
- To turn the freezer off, turn the temperature control to the minimum position, then unplug the unit from the power supply.
- The unit may not work at the set temperature on particularly hot days, or if the lid is opened too frequently. To ensure efficient operation, do not open the lid unnecessarily or for prolonged periods of time.

3. Getting Started

3.1 Unpacking

- **Packaging materials:** This product has been packaged to protect it against transportation damage. Remove all packaging materials from around and inside the appliance and keep the original packaging carton and materials in a safe place. It will help prevent any damage if the product needs to be transported in the future, and you can use it to store the appliance when it is not in use. In the event that the carton is to be disposed of, please recycle all packaging materials where possible.

Plastic wrapping can be a suffocation hazard for babies and young children, so ensure all packaging materials are out of their reach and disposed of safely.

- **Parts:** Check to ensure you have all the parts pictured opposite.
- **Power cord:** Unwind the power cord to its full length and inspect it for damage. Do not use the appliance if the appliance or its cord have been damaged or are not working properly. **In case of damage, contact our after sales support line for advice on examination, repair or return of the damaged product.**



- **Read the manual:** Before installing your new freezer, read all safety instructions, especially the sections on installation and electrical safety on page 4. Then follow the installation instructions below and on the next page.
- **Clean:** Make sure the freezer is disconnected from power supply before cleaning the interior surfaces and all internal accessories with lukewarm water, a soft cloth and a neutral/mild soap/detergent. This will remove any dust from transit and storage and help remove the typical smell of a brand new product. Then dry thoroughly. Important: Do not use harsh or abrasive detergents or powders as these will damage the finish.

3.2 Installation

3.2.1 Location

Install the appliance in an area that meets the following requirements:

- **Ambient temperature:** The ambient temperatures must correspond to the climate class (T) indicated on the rating plate of the appliance: 16°C - 43°C.
- **Floor surface:** The floor must be sturdy, level and strong enough to support the unit when it is fully loaded.
- **Areas to avoid:** Avoid areas where the appliance would be exposed to direct sunlight, sources of heat (stove, heater, radiator, etc.), extreme cold ambient temperatures or excessive moisture and high humidity. Installing it in the coolest area of the room will save energy consumption and running costs.

4. Use

4.1 Space Requirements

- **Clearances:** Ensure that air can circulate freely around the back of the cabinet, which is necessary to cool the compressor and condenser. Allow at least 10cm clear space at the back and the sides of the unit.
- **Overhanging wall units:** Ideally, the appliance should not be positioned below overhanging wall units. However, if the appliance must be positioned below an overhanging wall unit, make sure to allow sufficient room so you can comfortably open the lid and access the contents.

4.2 Electrical Connection

- **WARNING!** It must be possible to disconnect the appliance from the mains power supply; the plug must therefore be easily accessible after installation.
- **Before plugging in your new freezer, let it stand upright for at least 4 hours.** This will allow the refrigerant gases to settle into the compressor and reduce the possibility of a malfunction in the cooling system.
- **When first starting up, and after a period out of use, allow the unit to cool down on the MAX setting for at least 2 hours before placing food in the freezer.**
- The appliance must be earthed. The plug of the power supply cord is equipped with a contact for this purpose. Do not under any circumstances cut or remove the third (earth) prong from the power cord. If the plug does not fit your outlet, consult a licensed electrician for advice to have the outlet changed.
- Plug the unit into a dedicated, properly earthed wall outlet. Ensure that your outlet voltage and circuit frequency correspond to the voltage stated on the rating label.





- Secure the freezer's supply cord behind the unit. Do not leave it exposed or dangling to prevent injury and accidental disconnection from the power supply.
- Adjust the temperature control as described below.

4.3 Freezer Compartment

The freezer compartment is suitable for freezing fresh food and long-term storage (up to three months) of frozen food. It is designed to operate in ambient (surrounding air) temperatures between 16°C and 43°C. For convenient access and organized storage, the freezer compartment is equipped with a wire storage basket.

4.4 Freezing Fresh Food

- Only freeze fresh food that has been thoroughly cleaned.
- Do not store food uncovered in the freezer. Always use good quality, freezer-proof packaging to maintain food quality. Remove air from packages of solid food and seal bags tightly before freezing.
- Ensure that food placed in the freezer is dated and labeled. This will help you keep track of storage times.
- Keep portions small to ensure they are frozen (and subsequently defrosted) rapidly.
- Make sure that fresh, unfrozen food packages do not touch food that is already frozen, thus avoiding a temperature rise in the frozen food.
- When freezing food, do not push food together too much; leave some space for air to circulate around each item. Do not place packages directly against the back wall.
- When adding large amounts of fresh food to the freezer, keep in mind that it will take approximately 24 hours for fresh food to freeze to solid frozen state. For best results, do not add other fresh food to the freezer drawer during this time.
- Do not place hot foods or liquids which may evaporate in the freezer compartment.

4.5 Storing Frozen Food

- When buying frozen food, only buy quantities that you can store straight away; use an insulated container for your shopping and when you get home, place the food in the freezer immediately.
- When storing pre-packed, commercially frozen food, follow the food manufacturer's instructions for storing the food in a home freezer. Do not exceed any storage times listed on the packaging.
- Once you have opened a packet of frozen food, rewrap it airtight to prevent surface evaporation which causes drying or freezer burn.
- Do not place carbonated liquids such as bottles of fizzy drink in the freezer as the container could explode under pressure and damage the freezer.
- Do not refreeze food once it has been defrosted.
- Frozen food which has thawed accidentally should either be used immediately or thrown away. Alternatively, if the food is uncooked and has not been completely defrosted, it may be cooked and then refrozen.
- **CAUTION!** Do not remove items from the freezer if your hands are damp or wet as this could cause skin abrasions.





4.6 Saving Energy

- Locate the freezer in the coolest area of the room, away from heat-producing appliances and out of direct sunlight.
- Let hot foods cool to room temperature before placing them in the freezer.
- Overloading the freezer forces the compressor to run longer.
- Be sure to wrap foods properly, and wipe containers dry before placing them in the freezer. This cuts down on frost build-up inside the unit.
- Do not line the storage basket with aluminum foil, wax paper or paper toweling. Liners interfere with cold air circulation, making the freezer less efficient.
- Do not pack food packages close together as this prevents air circulating.
- Organize and label food to reduce lid openings and extended searches. Remove as many items as needed at one time and close the lid as soon as possible.
- Do not open the freezer lid unnecessarily or for too long, especially during a power failure.

4.7 Power Failure

- Most power failures are corrected within a few hours and should not affect the temperature inside your freezer, if you minimize the number of times the lid is opened. However, if the power is going to be off for a longer period of time, you need to take proper steps to protect your food.
- Do not refreeze frozen food without checking its condition first.
- If in doubt, discard the food. Do not refreeze food that has thawed completely.

4.8 Going Away?

- **Short vacation:** Leave the freezer operating during vacations of less than a month.
- **Long vacation:** If you are not going to use the freezer for longer periods, remove all food and unplug the power cord. Clean and dry the interior thoroughly. To prevent odor and mould growth, leave the lid open slightly, blocking it open, if necessary. (Restrict children's access to the room with the open freezer to avoid creating a child entrapment risk.)

4.9 Moving the Freezer

- Remove all food from inside the freezer, securely tape down the wire divider and basket and tape the lid shut.
- Protect the outside of the unit with a blanket or similar soft material and make sure the freezer stays secure in the upright position during transportation.



5. Troubleshooting

If you experience a problem with your chest freezer, check in the following table for solutions to help you solve the problem. If after these checks you still have a problem with your freezer, contact our after sales support line for advice.

CAUTION: Before troubleshooting, disconnect the power supply. Any troubleshooting that is not mentioned in this manual may only be carried out by a qualified electrician or similarly qualified person.

| Problem | Possible cause |
|---|--|
| The freezer does not work. | <ul style="list-style-type: none">• It is not plugged in.• The circuit breaker tripped or a blown fuse.• The thermostat knob is set to the minimum position. |
| The compressor turns on and off frequently. Does that indicate that there is a problem? | <ul style="list-style-type: none">• The room temperature is hotter than normal.• A large amount of food has been added to the freezer.• The lid is being opened too often.• The lid is not closed completely.• The temperature control is not set correctly.• The lid gasket does not seal properly.• The freezer does not have the correct ventilation clearances.• The freezer has recently been disconnected for a period of time. At least 2 hours are required for the freezer to cool down with the thermostat set to the highest (6) position. |
| The temperature inside the freezer is too warm. | <ul style="list-style-type: none">• The temperature control is set too warm. Turn the control to a cooler setting and allow several hours for the temperature to stabilize.• The lid is kept open too long or is opened too frequently. Warm air enters the freezer every time the lid is opened. Open the lid less often.• The lid is not closed completely.• The lid gasket does not seal properly.• A large amount of warm or hot food might have been stored recently. Wait until the freezer has had a chance to reach its selected temperature.• The freezer has recently been disconnected for a period of time. At least 2 hours are required for the freezer to cool down with the thermostat set to the MAX position. |



| | |
|--|---|
| <p>The temperature inside the freezer is too cold.</p> | <ul style="list-style-type: none"> • The temperature control is set too cold. Turn the control to a warmer setting and allow several hours for the temperature to stabilize. • The thermostat is set to the highest (6) position, which causes continuous running of the compressor and bypasses the temperature control. |
| <p>The temperature of the external freezer surface is warm.</p> | <ul style="list-style-type: none"> • The exterior freezer walls can be warmer than room temperature. This is normal while the compressor works to transfer heat from inside the freezer cabinet. |
| <p>There is a popping or cracking sound when the compressor comes on. Does that indicate a problem with cooling performance?</p> | <ul style="list-style-type: none"> • Metal parts undergo expansion and contraction, just as hot water pipes. This is normal. The sound will level off or disappear as the freezer continues to run. |
| <p>There is a bubbling or gurgling sound, like water boiling.</p> | <ul style="list-style-type: none"> • Refrigerant (used to cool the freezer) is circulating throughout the system. This is normal. |
| <p>There are vibrations; what is causing them? How can I stop the vibrations?</p> | <ul style="list-style-type: none"> • Check to ensure that the freezer is on a level surface. • The floor is uneven or weak. The freezer rocks on the floor when it is moved slightly. Be sure your floor can adequately support the freezer. • Put a piece of metal or timber underneath parts of the freezer to level it. • The freezer is touching the wall. Re-level the freezer and move it away from the wall. |
| <p>Moisture forms on the inside freezer walls.</p> | <ul style="list-style-type: none"> • Hot and humid weather increases the internal rate of frost build-up. This is normal. • The lid is slightly open. • The lid is kept open too long, or is opened too frequently. Open the lid less often. • The lid is not sealed properly. |
| <p>Moisture forms on the outside of the freezer.</p> | <ul style="list-style-type: none"> • The lid is slightly open, causing cold air from inside the freezer to meet warm, moist air from the outside. |
| <p>The lid does not close properly.</p> | <ul style="list-style-type: none"> • The freezer is not on a level surface. • The gasket is dirty. • The storage basket is out of position. |



6. Care and Cleaning

WARNING!

To reduce the risk of electric shock or injury, always switch off the appliance and disconnect it from the power supply before defrosting or cleaning it.

6.1 Defrosting the Freezer

- For efficient operation and minimum energy consumption, defrost the freezer compartment when the frost on the freezer walls is building up; do not let frost build up to more than 3 - 4mm thickness. Preferably, choose a time when your stock of frozen food is low. Then follow the simple steps below.
- Turn the temperature control to the minimum position, unplug the freezer and remove the food and storage basket. (Keep any frozen food temporarily in a fridge or cooler bag to keep defrosting to a minimum.)
- During defrosting, any ice and frost that has accumulated will melt into the freezer cabinet. To drain the water, you will need to open two plugs to the drainage hole; one is located at the bottom of a side panel (Fig. 1) and the other one at the internal bottom of the freezer cabinet (Fig. 2).

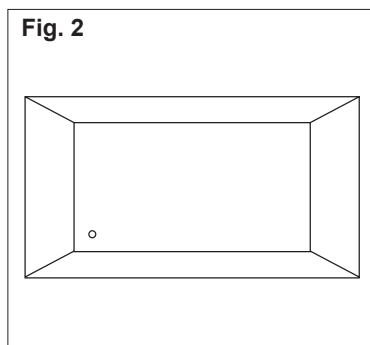
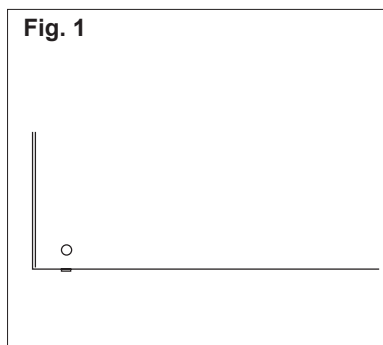

- Place a shallow tray and some dry towels underneath the outer drain plug for the water to drain into. Then unscrew the plug and pull out so the water can flow out the hole.
- Defrosting usually takes a few hours. To defrost faster keep the freezer lid open.
- Check the tray occasionally so the water does not overflow.
- Wipe any remaining water out of the freezer cabinet with a dry, soft cloth.
- When done, push the drain plug in and also re-plug the drain plug inside the freezer cabinet.
- Clean and/or dry all interior freezer surfaces thoroughly, then turn the freezer temperature control to the desired setting and plug in the freezer to restart it.

WARNING!

- Never use sharp or metallic tools to scrape off frost from the evaporator as you could damage it. To scrape ice off surfaces, use a plastic scraper.
- Never use boiling water to accelerate defrosting as it may damage the plastic parts.

6.2 Cleaning the Freezer

For hygienic reasons, clean the appliance interior and accessories regularly. We recommend cleaning the freezer after defrosting it, while all frozen food packages and the storage basket are already removed from the compartment.

- Make sure the temperature control is set to the minimum position, the freezer is unplugged from the power supply and all food and the storage basket are removed.
- Wash the inside surfaces and the interior accessories with a damp, warm cloth moistened in a water and baking soda solution. The solution should be about 2 tablespoons of baking soda to 1 liter of water. Rinse and wipe dry with a soft cloth.
- Clean the outside of the unit with a damp, well wrung out cloth, keeping the area of the controls dry. Keep the lid gasket (seal) clean.
- Regularly examine the drain in the freezer for defrost water. If necessary, clean the drain. If the drain is blocked, water will collect in the base of the appliance.
- After cleaning/defrosting, push the drain plug in and also re-plug the drain plug inside the freezer cabinet.
- After everything is dry, place the appliance back into service.
- Allow approximately 1 - 2 hours for the cabinet to cool down again (depending on the length of time the freezer was disconnected from power). To speed up the cooling down time, set the thermostat to the MAX position for 2 hours, then turn it back to your normal position and return the food to the freezer.

WARNING!

- Never clean the unit with an abrasive, acid, oil or solvent based cleaning agent, or with abrasive pads or scourers. Never use flammable fluids or sprays for cleaning as the fumes from these substances can create a fire hazard or explosion.
- Never clean the appliance with a steam cleaner. Moisture could accumulate in the electrical components, danger of electric shock! Hot vapors can lead to the damage of plastic parts.
- The appliance must be completely dry before it is placed back into service.

IMPORTANT!

- Ethereal oils and organic solvents can attack plastic parts, e.g. lemon juice or the juice from orange peel, butyric acid, or cleansers that contain acetic acid. Do not allow such substances to come into contact with the appliance parts.

7. Technical Data

| | |
|--------------------------|---|
| Rated voltage | 220 - 240VAC |
| Rated frequency | 50Hz |
| Rated current | 1.1A (HS-384CN) 0.6A (HS-185CN) |
| Climate class | T |
| Dimensions (mm) | 850 (H) x 1115 (W) x 670 (D) - Model HS-384CN 730 (H) x 850 (W) x 523 (D) - Model HS-185CN |
| Capacity | 146L (HS-185CN) 295L (HS-384CN) Note: Volume can be subject to manufacturing tolerance within 3% |
| Refrigerant | R600a, 62g (HS-384CN), 52g (HS-185CN) |
| Insulation blowing agent | Cyclopentane |
| Net weight | 42kg (HS-384CN); 26kg (HS-185CN) |

8. Notice

8.1 Compliance

This appliance has been fully tested and meets all requirements as set out by standards AS/NZS 60335.1 and AS/NZS 60335.2.24.

8.2 Responsible Disposal

- At the end of its working life, do not throw this appliance out with your household rubbish. Electrical and electronic products contain substances that can have a detrimental effect on the environment and human health if disposed of inappropriately. Observe any local regulations regarding the disposal of electrical consumer goods and dispose of it appropriately for recycling and recovery of the refrigerant and blowing agent. Contact your municipal authorities for advice on recycling facilities in your area.
- This refrigeration appliance contains flammable refrigerants and insulation blowing gases, which must be removed before disposal. Contact your municipal authorities for any codes or regulations concerning the disposal of such materials.
- **DANGER! Risk of child entrapment:** When discarding the freezer, make sure to take off the lid so that children cannot easily climb in and get trapped inside.







LIVING & CO[®]

Warranty

We pride ourselves on producing a range of quality products that are both packed with features and completely reliable. We are so confident in our products, we back them up with a two years warranty. Now you too can relax knowing that you are covered.

Customer Helpline NZ: 0800 422 274
This product is covered by two years warranty
when accompanied by proof of purchase.

AFTER SALES SUPPORT

  0800 422 274